



Profile cutterhead set ProfilCut Q - Panel raising

Application:

For panel raising profiles for framed doors, ceilings, wall coverings etc.

Machine:

Stationary routers with/without CNC control, milling machines with spindles to mount shank tools.

Workpiece material:

Softwood and hardwood.

Technical information:

Panel edge jointing by mounting an additional jointing cutterhead ID **041221**. Cutterhead with changeable knives and shear angle.

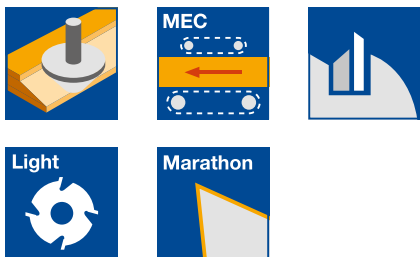

Panel raising depth max. 49 mm

SG 599 2 53, TR 811 0, WE 550 2 53

Tool Type	ABM mm	Z	n_{max} min^{-1}	ID
Cutterhead	132x43x20	2	11600	125273
Cover plate	46x9.5x20			007925
Cutterhead mounted on arbor	1-part			426095

Unless stated otherwise, tools are right hand rotation.
Cutter arbor see section Clamping Systems.

Spare knives:

Part-no.	BEZ	ABM mm	QAL	VE PCS	ID
1	Turnblade knife	12x12x1.5	HW-05F	10	005081 ●
	ProfilCut Q knife	60x20.47x2	MC		619343

Spare parts:

Part-no.	BEZ	ABM mm	ID
2	Clamping wedge profiled	57x28.97x7.25	629255
3	Clamping screw w. disc, Torx® 25	M6x18.5	007442 ●
4	Torx® key	Torx® 25	117504 ●
	Oval head screw Torx® 15	M4x6	006225 ●
	Torx® key	Torx® 15	117507 ●

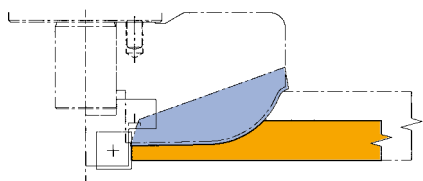

Example

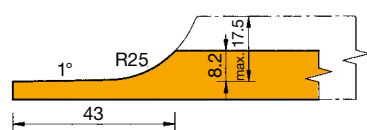

Jointing

WW 200 2 NN

Tool Type	ABM mm	QAL	Z	ID
Jointing cutterhead	30/46x12/22.5x20	HW	2	041221



Архангельск (8182)63-90-72
Астана (7172)727-132
Астрахань (8512)99-46-04
Барнаул (3852)73-04-60
Белгород (4722)40-23-64
Брянск (4832)59-03-52
Владивосток (423)249-28-31
Волгоград (844)278-03-48
Вологда (8172)26-41-59
Воронеж (473)204-51-73
Екатеринбург (343)384-55-89
Иваново (4932)77-34-06

Ижевск (3412)26-03-58
Иркутск (395)279-98-46
Казань (843)206-01-48
Калининград (4012)72-03-81
Калуга (4842)92-23-67
Кемерово (3842)65-04-62
Киров (8332)68-02-04
Краснодар (861)203-40-90
Красноярск (391)204-63-61
Курск (4712)77-13-04
Липецк (4742)52-20-81
Киргизия (996)312-96-26-47

Магнитогорск (3519)55-03-13
Москва (495)268-04-70
Мурманск (8152)59-64-93
Набережные Челны (8552)20-53-41
Нижний Новгород (831)429-08-12
Новокузнецк (3843)20-46-81
Новосибирск (383)227-86-73
Омск (3812)21-46-40
Орел (4862)44-53-42
Оренбург (3532)37-68-04
Пенза (8412)22-31-16
Россия (495)268-04-70

Пермь (342)205-81-47
Ростов-на-Дону (863)308-18-15
Рязань (4912)46-61-64
Самара (846)206-03-16
Санкт-Петербург (812)309-46-40
Саратов (845)249-38-78
Севастополь (8692)22-31-93
Симферополь (3652)67-13-56
Смоленск (4812)29-41-54
Сочи (862)225-72-31
Ставрополь (8652)20-65-13
Казахстан (772)734-952-31

Сургут (3462)77-98-35
Тверь (4822)63-31-35
Томск (3822)98-41-53
Тула (4872)74-02-29
Тюмень (3452)66-21-18
Ульяновск (8422)24-23-59
Уфа (347)229-48-12
Хабаровск (4212)92-98-04
Челябинск (351)202-03-61
Череповец (8202)49-02-64
Ярославль (4852)69-52-93

5. Routing

5.4 Profiling

5.4.3 Tools for furniture and interior construction



Profile cutterhead set ProfilCut Q - Panel raising

Application:

For panel raising profiles for framed doors, ceilings, wall coverings etc.

Machine:

Stationary routers with/without CNC control, milling machines with spindles to mount shank tools.

Workpiece material:

Softwood and hardwood.

Technical information:

Panel edge jointing by mounting an additional jointing cutterhead ID **041221**. Cutterhead with changeable knives and shear angle. Profile can be changed by replacing the knives.



Panel raising depth max. 40 / 50 mm with/without jointing

SG 599 2 53, TR 811 0, WE 550 2 53

Tool Type	P	ABM mm	QAL	Z	n_{max} min ⁻¹	ID
Cutterhead	1	110x40/40x20	MC	2	13800	125274 ●
Cover plate		46x9.5x20				007925
Cutterhead mounted on arbor		1-part	MC			426096 □

Unless stated otherwise, tools are right hand rotation.

Cutter arbor see section Clamping Systems.

Spare knives:

Part-no.	BEZ	P	ABM mm	QAL	VE PCS	ID
	Turnblade knife		12x12x1.5	HW-05F	10	005081 ●
1	ProfilCut Q knife	1	50x14.5x2	MC		619344
1	ProfilCut Q knife	2	50x14.56x2	MC		619345

Spare parts:

Part-no.	BEZ	ABM mm	ID
2	Clamping wedge profiled	47x23x7.25	629256
3	Clamping screw w. disc, Torx® 25	M6x18.5	007442 ●
4	Torx® key	Torx® 25	117504 ●
	Oval head screw Torx® 15	M4x6	006225 ●
	Torx® key	Torx® 15	117507 ●

Jointing

WW 200 2 NN

Tool Type	ABM mm	QAL	Z	ID
Jointing cutterhead	30/46x12/22.5x20	HW	2	041221

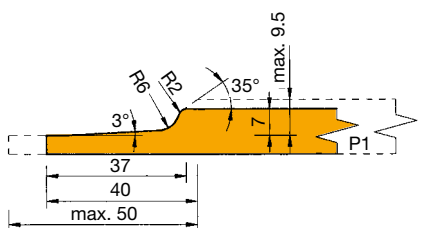

P1

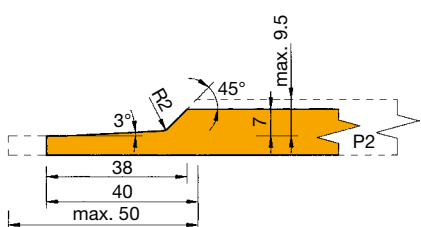

P2

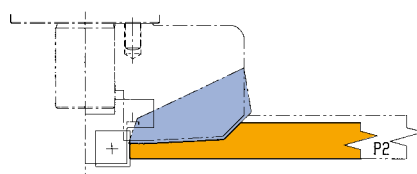
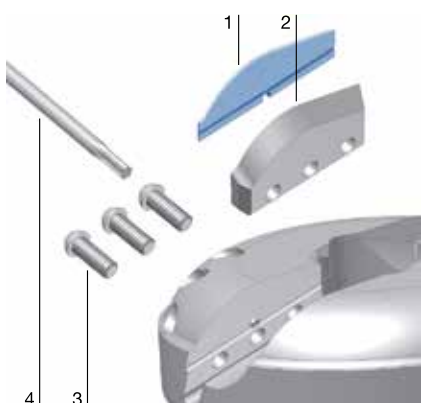

Example

5. Routing

5.4 Profiling

5.4.3 Tools for furniture and interior construction

Profile cutterhead set ProfilCut Q - Panel raising



Application:

For panel raising profiles for framed doors, ceilings, wall coverings etc.

Machine:

Stationary routers with/without CNC control, milling machines with spindles to mount shank tools.

Workpiece material:

Softwood and hardwood.

Technical information:

Panel edge jointing by mounting an additional jointing cutterhead ID **041221**. Cutterhead with changeable knives and shear angle. Profile can be changed by replacing the knives.

Panel raising depth max. 54 mm

SG 599 2 53, TR 811 0, WE 550 2 53

Tool Type	P	ABM mm	QAL	Z	n _{max} min ⁻¹	ID
Cutterhead	1	124x20/36x20	MC	2/2	12300	125275
Cover plate		46x9.5x20				007925
Cutterhead mounted on arbor	1	1-part	MC	2/2	12300	426097

Unless stated otherwise, tools are right hand rotation with profile P1.

Cutter arbor see section Clamping Systems.

Spare knives:

Part-no.	BEZ	P	ABM mm	QAL	VE PCS	ID
	Turnblade knife		12x12x1.5	HW-05F	10	005081 ●
1	ProfilCut Q knife	1	20x27x2	MC		619346
1	ProfilCut Q knife	2	20x27x2	MC		619347
1	ProfilCut Q knife	3	20x27x2	MC		619348
1	ProfilCut Q knife	4	20x27x2	MC		619349
1	ProfilCut Q knife	5	20x27x2	MC		619350
2	Turnblade knife		40x8x1.5	HW-30F	10	005074 ●

Spare parts:

Part-no.	BEZ	P	ABM mm	ID
3	Clamping wedge profiled	1-5	18x37.46x8.27	629257
4	Clamping wedge		37x16.8x7.25	009577 ●
5	Clamping screw w. disc, Torx® 25		M6x18.5	007442 ●
6	Torx® key		Torx® 25	117504 ●
	Oval head screw Torx® 15		M4x6	006225 ●
	Torx® key		Torx® 15	117507 ●
	Cover plate		46x9.5x20	007925

Jointing

WW 200 2 NN

Tool Type	ABM mm	QAL	Z	ID
Jointing cutterhead	30/46x12/22.5x20	HW	2	041221

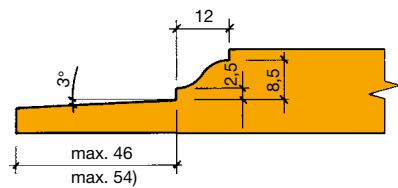
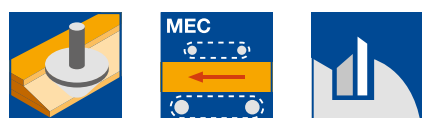

P1

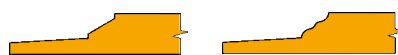

P2



P3



P4



P5

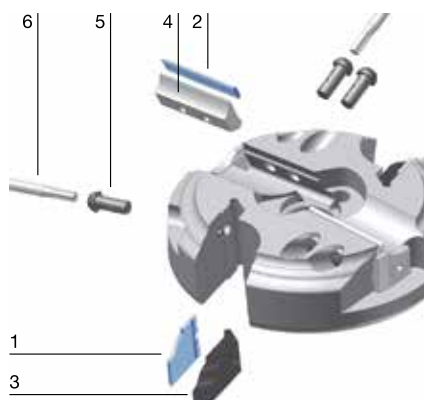

1

3

5. Routing

5.4 Profiling

5.4.3 Tools for furniture and interior construction



Profile cutterhead set ProfilCut Q - Panel raising

Application:

For panel raising profiles for framed doors, ceilings, wall coverings etc.

Machine:

Stationary routers with/without CNC control, milling machines with spindles to mount shank tools.

Workpiece material:

Softwood and hardwood.

Technical information:

Panel edge jointing by mounting an additional jointing cutterhead ID **041221**. Cutterhead with changeable knives and shear angle. Profile can be changed by replacing the knives.



Panel raising depth max. 50 mm

SG 599 2 53, TR 811 0, WE 550 2 53

Tool Type	P	ABM mm	QAL	Z	n _{max} min ⁻¹	ID
Cutterhead	1	131x20/36x20	MC	2/2	11600	125276
Cover plate		46x9.5x20				007925
Cutterhead mounted on arbor	1	1-part	MC	2/2	11600	426098

Unless stated otherwise, tools are right hand rotation with profile P1.

Cutter arbor see section Clamping Systems.

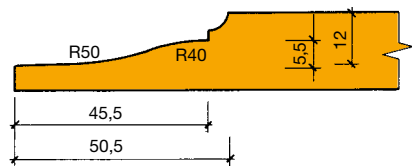

P1

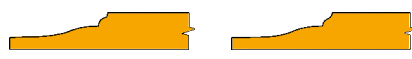

P2



P3



P4



P5

Profile examples

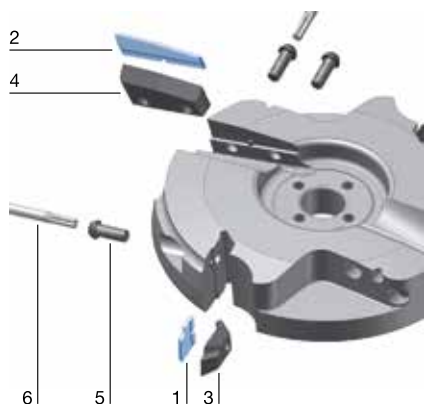

Spare knives:

Part-no.	BEZ	P	ABM mm	QAL	VE PCS	ID
	Turnblade knife		12x12x1.5	HW-05F	10	005081 ●
1	ProfilCut Q knife	1	20x16x2	MC		619351
1	ProfilCut Q knife	2	20x16x2	MC		619352
1	ProfilCut Q knife	3	20x16x2	MC		619353
1	ProfilCut Q knife	4	20x16x2	MC		619354
1	ProfilCut Q knife	5	20x16x2	MC		619355
2	ProfilCut Q knife (pan.rais.)		50x11.68x2	MC		619356

Spare parts:

Part-no.	BEZ	P	ABM mm	ID
3	Clamping wedge profiled	1-5	18x26.46x8.27 (P1-5)	629258
4	Clamping wedge profiled		47x20.18x7.25 (raised panel)	629259
5	Clamping screw w. disc, Torx® 25		M6x18.5	007442 ●
6	Torx® key		Torx® 25	117504 ●
	Oval head screw Torx® 15		M4x6	006225 ●
	Cover plate		46x9.5x20	007925

Jointing

WW 200 2 NN

Tool Type	ABM mm	QAL	Z	ID
Jointing cutterhead	30/46x12/22.5x20	HW	2	041221

Архангельск (8182)63-90-72
Астана (7172)727-132
Астрахань (8512)99-46-04
Барнаул (3852)73-04-60
Белгород (4722)40-23-64
Брянск (4832)59-03-52
Владивосток (423)249-28-31
Волгоград (844)278-03-48
Вологда (8172)26-41-59
Воронеж (473)204-51-73
Екатеринбург (343)384-55-89
Иваново (4932)77-34-06

Ижевск (3412)26-03-58
Иркутск (395)279-98-46
Казань (843)206-01-48
Калининград (4012)72-03-81
Калуга (4842)92-23-67
Кемерово (3842)65-04-62
Киров (8332)68-02-04
Краснодар (861)203-40-90
Красноярск (391)204-63-61
Курск (4712)77-13-04
Липецк (4742)52-20-81
Киргизия (996)312-96-26-47

Магнитогорск (3519)55-03-13
Москва (495)268-04-70
Мурманск (8152)59-64-93
Набережные Челны (8552)20-53-41
Нижегород (831)429-08-12
Новокузнецк (3843)20-46-81
Новосибирск (383)227-86-73
Омск (3812)21-46-40
Орел (4862)44-53-42
Оренбург (3532)37-68-04
Пенза (8412)22-31-16
Россия (495)268-04-70

Пермь (342)205-81-47
Ростов-на-Дону (863)308-18-15
Рязань (4912)46-61-64
Самара (846)206-03-16
Санкт-Петербург (812)309-46-40
Саратов (845)249-38-78
Севастополь (8692)22-31-93
Симферополь (3652)67-13-56
Смоленск (4812)29-41-54
Сочи (862)225-72-31
Ставрополь (8652)20-65-13
Казахстан (772)734-952-31

Сургут (3462)77-98-35
Тверь (4822)63-31-35
Томск (3822)98-41-53
Тула (4872)74-02-29
Тюмень (3452)66-21-18
Ульяновск (8422)24-23-59
Уфа (347)229-48-12
Хабаровск (4212)92-98-04
Челябинск (351)202-03-61
Череповец (8202)49-02-64
Ярославль (4852)69-52-93